

Introduction

Your Partlow brand 1880 DC Process is one model in a family of 1/8 DIN units which offers breakthrough display technology as well as easy-to-program single-line parameters. Designed to provide instant visual feedback regarding an application's key input value, the 1880 not only has a 0.71" high LED display (27% larger than other 1/8 DIN units), but also the ability to change display color based on process status (programmable parameter in Operation Mode). Easy programming is made possible via a help function and a secondary legend display.

This manual will guide you through the installation and wiring of your 1880 unit with information on proper panel mounting and rear terminal layout and wiring instructions. In addition, the instrument's operation, programming, and configuration modes are thoroughly explained. The Operation Mode provides day to day operation and allows editing of preset values. The Program Mode enables the configuration of various parameters prior to initial operation. These parameters include those for basic configuration as well as other settable features which will enhance the functionality and usability of the device. The Configuration Mode allows selection of how outputs and special functions are utilized.

This manual also provides information on the 1880 DC Process' alarms; transistor, relay, and linear outputs; product specifications; and ordering and warranty procedures.



Features

- AWESOME 0.71" high digit LED display
- Programmable color change display based on an event
- Programmable help function and secondary legend display
- High and low alarm outputs
- mA inputs to 50mA, DCV inputs to ± 10 Volts and ± 100 mV
- Tare function
- Standard outputs: two NPN transistors & one relay (optional 2nd relay)
- 100 ms sample time with 0.03% accuracy
- Optional RS-485 plug in card
- CE approved

Index

Installation	
Panel Mounting	page 2
Wiring	page 3
Operation	
Front Panel	page 4
Operation Mode	page 5-6
Programming	
Program Mode	page 7-10
Configuration	
Configuration Mode	page 11-14
Appendix A	
Specifications	page 15
General	
Ordering Information	page 16
Warranty	page 16

Technical Manual

Partlow^{Brand} Series 1880 DC Process (1880-2XXX)



NEMA 4X

INSTALLATION

PANEL MOUNTING

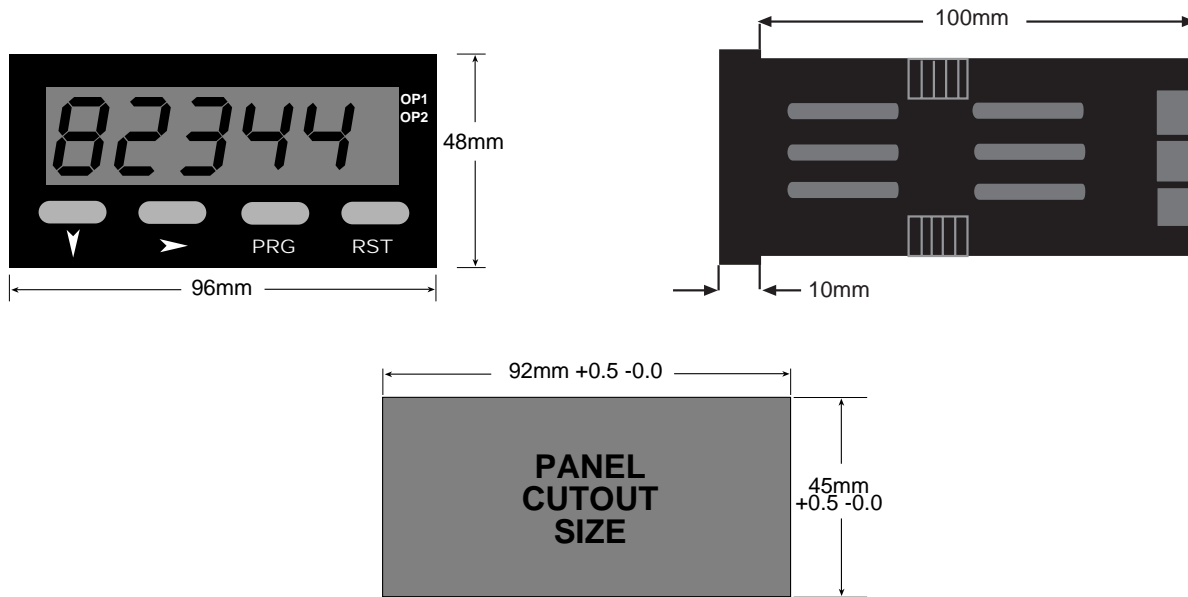

The instrument can be mounted in a panel with a thickness of up to 6mm. The cutout(s) should be made based on the recommended panel opening illustrated in the drawing above.

Mounting Grooves

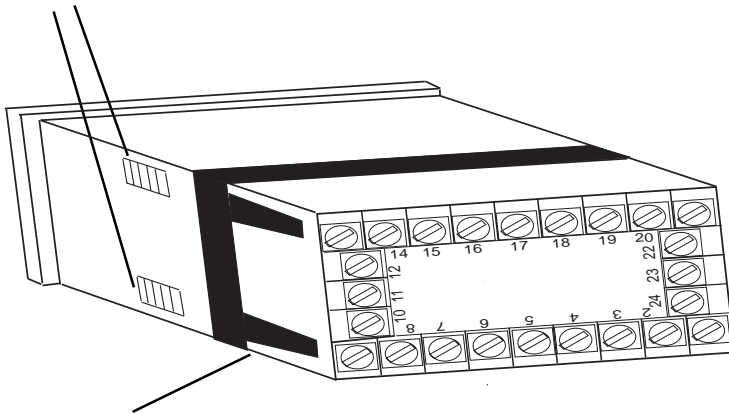

Insert the unit in the panel through the cutout. Ensure that the panel gasket is not distorted and the instrument is positioned squarely against the panel. Slide the mounting clamp into place on the instrument, as shown to the left, and push it forward until it is firmly in contact with the rear face of the mounting panel and the tabs on the bracket arm are seated in the mounting grooves on the side of the unit.

The electronic components of the instrument can be removed from the housing after installation without disconnecting the wiring. To remove the components, grip the side edges of the panel and pull the instrument forward. Take note of orientation of the unit for subsequent replacement in the housing.

Bracket Arm

INSTALLATION

WIRING

REAR TERMINAL CONNECTIONS

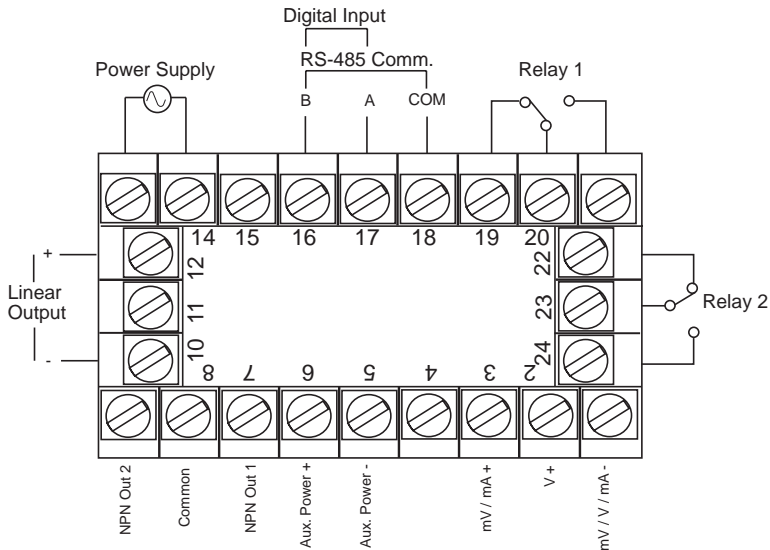

Transistor Outputs

Your unit comes standard with 2 NPN outputs which are activated by each of the alarms. Transistor Output 1, which is tied to Alarm 1, is on Terminal #7. Transistor Output 2, which is tied to Alarm 2, is on Terminal #9. Terminal #8 serves as the common connection for both transistor outputs.

Relay Outputs

Your unit comes standard with a relay output which is tied to Alarm 1. Terminal #19 is NC, Terminal #20 is common, and Terminal #21 is NO. A second relay output tied to the operation of Alarm 2 can be added as an option at the time of order or later installed in the field. Terminal #22 is NC, Terminal #23 is common, and Terminal #24 is NO.

DC Inputs

Your unit accepts millivolt, Volt, or milliamp DC ranges. Terminal #1 is used for mV, V, or mA negative inputs. Terminal #2 is used for V positive inputs, while Terminal #3 is used for mV or mA positive inputs.

Control/Digital Inputs

A digital input board, which utilizes Terminals #16 & #17, can be installed as an option. The input can be programmed in Configuration Mode to perform one of two functions:

- *Tare*: When activated, the unit will create an automatic offset by referencing the currently measured value as the new zero point.
- *Security*: When activated, the Program and Calibration Modes will not be accessible from the front panel.

Please note that this option is mutually exclusive with the RS-485 serial communication option.

Input Power

For an AC powered unit, Terminal #13 serves as the line or Hot side connection for AC powered units and as the positive side for DC powered units. The neutral side for AC powered units and the negative side for DC powered units are connected to Terminal #14.

Serial Communication

An RS-485 communication board, utilizing ASCII protocol, can be installed as an option. Terminals #16 & #17 serve as the B and A connections respectively, while Terminal #18 is connected as the common.

Linear Output

An option board may be installed that provides a 10 bit linear output signal relative to the Process Value. Terminal #12 is the positive side of the connection, and Terminal #10 is the negative side. The default range of the output is 4-20 mA, but can be changed via the Configuration Mode to 0-20 mA, 0-10 VDC, 2-10 VDC, 0-5 VDC, or 1-5 VDC.

Terminals 4, 11, & 15 are not used.

OPERATION

FRONT PANEL



Key Functions

Key	Function
Down	<i>In Operation Mode:</i> Used in Edit Operation to decrement the digit highlighted by the Scroll key. <i>In Program & Config. Modes:</i> Used in Edit Operation to decrement the digit highlighted by the Scroll key, if the setting is a numerical value, or present the next in the series of choices for that parameter.
Scroll	<i>In All modes:</i> Moves the unit into Edit Operation, which is indicated by the left most digit flashing. Successive presses of the key are used to move to the digit to be edited. Wrap around will occur from least significant digit to most significant digit.
Program	<i>In Operation Mode:</i> Used to move between the process value display & the presets and to enter an edited preset value. Holding the key down for 3 seconds will cause the unit to enter Program Mode. <i>In Program Mode:</i> Used to move from one parameter to the next and enter the edited parameter values. Holding the key down for 3 seconds will cause the unit to return to Operation Mode. <i>In Config. Mode:</i> Used to move from one parameter to the next and enter the edited parameter values.
Reset	<i>In Operation Mode:</i> Resets a latched alarm if pressed while the process value is being viewed. Pressing this key while viewing the max or min value will cause those values to be reset. <i>In Program & Config. Modes:</i> No function.
Down & Scroll	<i>In All modes:</i> Will abort an Edit Operation and return the preset/parameter to its previous value.

Key Functions

Key	Function
Down & Program	<i>In Config. mode:</i> Holding down both keys for 3 seconds will cause the unit to return to Operation Mode. <i>In Operation & Program Modes:</i> Holding down both keys for 3 seconds will cause the unit to enter to Config. Mode.

Display Functions

Key	Function
Primary	<i>In Operation Mode:</i> Default display is the Process Value. Can be scrolled using the program key to display other Operation Mode values. If the "Help" function is enabled, this display will first show the parameter description for 3 seconds (example - page 6). <i>In Program & Config. Modes:</i> Displays the value or selection for the current parameter. If the "Help" function is enabled, this display will first show the parameter description for 3 seconds (example - page 7).
Secondary	<i>In Operation Mode:</i> Provides an alpha or numeric identification of the value on the primary display. This display is blank when the Process Value is being shown. <i>In Program & Config. Modes:</i> Provides a 1 digit alpha or numeric character to indicate which parameter value is being shown on the primary display.
Output Indicators	<i>In Operation Mode:</i> Illuminates when Output 1 and/or Output 2 is active. <i>In Program & Config. Modes:</i> No function.

OPERATION

OPERATION MODE

CHANGING A PRESET VALUE



Default display is the process value.



Pressing the Program Key will cause the display description to appear on the main display.* If there is no key activity for 3 seconds, the primary display will switch back to the process value.



Maximum (High) Value: Displays the maximum process value the unit has received as an input. The value can be reset (only while being displayed) by pressing the Reset Key.



Minimum (Low) Value: Displays the minimum process value the unit has received as an input. The value can be reset (only while being displayed) by pressing the Reset Key.



Alarm 1 Elapsed Time: Displays the accumulated amount of time the alarm 1 condition was present. This value will continue to accumulate until it is reset by pressing the Reset Key (while the value is being displayed). The value is displayed in mm:ss up to 99 min 59 secs., then changes over to mmm.m



Alarm 1 Value: Defines the process value at or above which Alarm 1 will activate if set to Process High Alarm in Configuration Mode or the process value at or below which Alarm 1 will be active if set to Process Low Alarm in Configuration Mode. The default value is 100.00

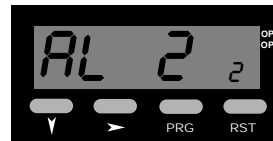

Alarm 2 Value: Defines the process value at or above which Alarm 2 will activate if set to Process High Alarm in Configuration Mode or the process value at or below which Alarm 2 will be active if set to Process Low Alarm in Configuration Mode. The default value is 100.00



Total: Displays the total value based upon integration of the input signal using a programmable time base. The value can be reset (only while being displayed) by pressing the Reset Key.

* Parameter descriptions will not appear on the primary display if the "Help" function has been disabled.

OPERATION

OPERATION MODE *Continued*

OTHER OPERATING DISPLAYS



Over Range Display: Appears if the process value becomes higher than the input full scale value.



Sensor Break Display: Appears if the unit does not receive an input signal for two seconds.



Under Range Display: Appears if the process value becomes lower than the input full scale value.

CHANGING AN ALARM VALUE



Default display is the the Process Value.



Use the Scroll Key to move from left to right and highlight the digit that needs to be changed. Wrap around will occur from the least significant to the most significant digit.

PRG 5 Times



From the Process Value display, scroll through the other Operation Mode values until Alarm 1 appears.*



Use the Down Key to decrement the digit until the desired value appears. The display will wrap around from 0 to 9.

PRG PRG



To change the Alarm value, press the Scroll Key. If there was no key activity for 3 seconds, the Alarm value will appear (one digit description shown on secondary display); however, press the Scroll Key in order to edit. The unit will now be in Edit Operation as signified by the most significant digit flashing.**



After the desired digits have been changed, press the Program Key to enter the new value. The new value will appear on the main display without any flashing digits. Press the Program Key again and the parameter description will appear on the main display.

* Parameter descriptions will not appear on the primary display if the "Help" function has been disabled.

** Edit Operation cannot be accessed if the Preset Lock has been enabled in Program Mode.

PROGRAMMING

PROGRAM MODE

ENTERING PROGRAM MODE AND BASIC OPERATION

The Program Mode can be accessed from the Operation Mode by holding the Program Key for 3 seconds.

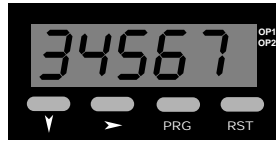

 for 3 seconds

The name of the first parameter will appear on the primary display.*

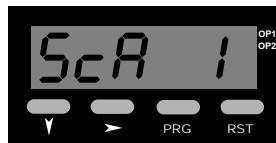

 PRG

Successive presses of the Program Key will scroll the display through the remaining parameters in the Program Mode. To exit Program Mode, hold the Program Key for 3 seconds.

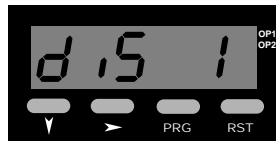

 PRG

* Parameter names will not appear on the main display if the "Help" function has been disabled in Program Mode.

Edit Operation

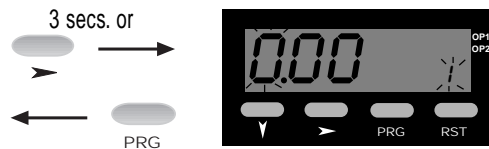

Pressing the Scroll Key or no key activity for 3 seconds will display the value for that parameter. The secondary display will indicate the one digit identifier for the parameter. The digit in the secondary display will flash to indicate the unit is in Program Mode. If the Scroll Key was pressed (instead of waiting 3 seconds), the unit is in Edit Operation, as indicated by the MSD flashing. If there had been no key activity for 3 seconds, press the scroll key to enter Edit Operation (MSD flashing). Use the scroll and edit buttons to change the value as in Operation Mode, described on page 6. Press the Program Key to enter any changes.

PARAMETER SEQUENCE



 PRG

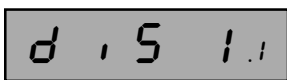

 PRG

Scaling Point 1

Function: Sets the first sensor input value point (based on percentage of full scale) which will be used in establishing a curve for scaling sensor inputs into engineering unit values. Pressing the Reset Key will serve as a teach function and input the sensor value currently being read

Adjustment Range: -0 to 100%

Default Value: 0.00

Display Point 1

Function: Provides the engineering unit value that will be displayed corresponding to the sensor input value set in the Scaling Point 1 parameter

Adjustment Range: -19999 to 99999

Default Value: 0.00

PROGRAM MODE Continued



Scaling Point 2

Function: Sets the second sensor input value point (based on percentage of full scale) which will be used in establishing a curve for scaling sensor inputs into engineering unit values. Pressing the Reset Key will serve as a teach function and input the sensor value currently being read

Adjustment Range: -19999 to 99999

Default Value: 99999

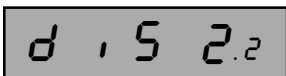

Display Point 2

Function: Provides the engineering unit value that will be displayed corresponding to the sensor input value set in the Scaling Point 2 parameter

Adjustment Range: -19999 to 99999

Default Value: 100.00

The scaling process can be repeated up to a total of 10 scale and display points.

Scale and display points will continue to be offered (up to 10 total) so long as 100% (the full scale limit) has not been selected as a scaling point.



Decimal Position

Function: Sets the position of the decimal point for use in displaying the process and alarm values

Adjustment Range: 0 to 0.000

Default Setting: 0.00

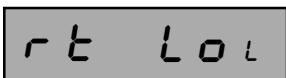

Retransmission Scale Minimum *(Appears only if a retransmission output has been enabled in Configuration mode)*

Function: Defines the lower end of the linear scale for the retransmission output by defining the value equated to the minimum output signal

Adjustment Range: -19999 to 99999

Default Value: 0.00

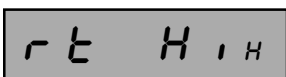

Retransmission Scale Maximum *(Appears only if a retransmission output has been enabled in Configuration mode)*

Function: Defines the upper end of the linear scale for the retransmission output by defining the value equated to the maximum output signal

Adjustment Range: -19999 to 99999

Default Value: 100.00

PROGRAM MODE Continued

o F F 0

PRG

Process Variable Offset

Function: Corrects a known offset of the input in order to more accurately display the process value

Adjustment Range: -19999 to 99999

Default Value: 0.00

F i l t F

PRG

Input Filter Time

Function: Filters the input over a user definable time period to minimize the effect on the Process Value of any extraneous impulses

Adjustment Range: 0.0 (Off) to 100.0

Default Value: 2.0

A d d r A

PRG

Communication Address *(Appears only if communication board is installed and activated)*

Function: Defines the unique communication address of the instrument

Adjustment Range: 1 to 99

Default Value: 1

b A u d b

PRG

Baud Rate *(Appears only if communication board is installed and activated)*

Function: Selects the serial communication speed

Adjustment Range:

1200

1200 BPS

2400

2400 BPS

4800

4800 BPS

9600

9600 BPS

Default Value: 4800

C o l o r 0

PRG

Display Color Change

Function: Defines the color of the display for prior to and after the preset value is reached

Adjustment Range:

r E d

Red: The display will always be red

G r E E n

Green: The display will always be green

G n _ r d

Green to Red: The display will be green when no alarm condition is present. It will turn red when either alarm is active

r d _ G n

Red to Green: The display will be red when no alarm condition is present. It will turn green when either alarm is active

Default Value: Green to Red

PROGRAM MODE Continued

Lock P

PRG

HELP h

Alarm Lock

Function: Determines whether the Alarm Values can be changed via the front panel

Adjustment Range:

En

d.S

Enable: Alarm values can be viewed and changed

Disabled: Alarm values are read only

Default Value: Enable

Help Prompt

Function: Determines whether the multi-character parameter name will appear on the main display for 3 seconds prior to the parameter value appearing

Adjustment Range:

HLP Y

HLP N

Help - Yes: Multi-character parameter descriptions will appear on the primary display. The value associated with that parameter will appear by pressing the scroll key or waiting for 3 seconds

Help - No: Only the parameter values will appear on the primary display. The parameter can be identified by a single digit in the secondary display

Default Value: Help - Yes

CONFIGURATION

CONFIGURATION MODE

ENTERING CONFIGURATION MODE AND BASIC OPERATION

The Configuration Mode can be accessed from the Operation Mode by holding the Down and Program Keys for 3 seconds.

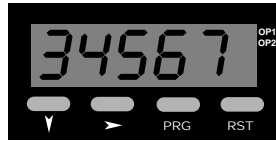

The name of the first parameter will appear on the primary display.*



Successive presses of the Program Key will scroll the display through the remaining parameters in the Configuration Mode. To exit Configuration Mode, hold the Down and Program Keys for 3 seconds.

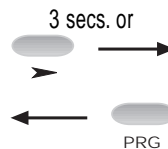
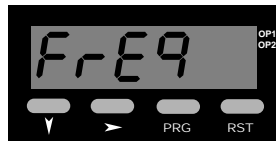

Edit Operation



Pressing the Scroll Key or no key activity for 3 seconds will display the value for that parameter. The secondary display will indicate the one digit identifier for the parameter. The digit in the secondary display will flash to indicate the unit is in Configuration Mode. If the Scroll Key was pressed (instead of waiting 3 seconds), the unit is in Edit Operation, as indicated by the MSD flashing. If there had been no key activity for 3 seconds, press the scroll key to enter Edit Operation (MSD flashing). Use the scroll and edit buttons to change the value as in Operation Mode, described on page 6. Press the Program Key to enter any changes.

* Parameter names will not appear on the main display if the "Help" function has been disabled in Program Mode.

PARAMETER SEQUENCE

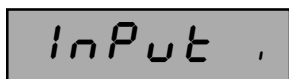

Input Range

Function: Selects the DC input range

Adjustment Range:

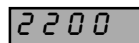

0-20 mA

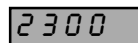

4-20 mA

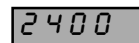

10-50 mA

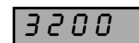

0-5 Volts DC

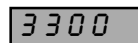

1-5 Volts DC

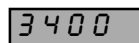

0-10 Volts DC

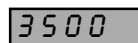

2-10 Volts DC

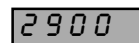

±100 mV

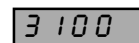

±1 Volts DC

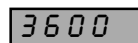

±10 Volts DC



CONFIGURATION MODE *Continued*

FRF9 F

Power Supply Frequency

Function: Although the instrument is designed to handle either 50 or 60 Hz inputs automatically, to ensure proper filtering of the input signal, it is necessary to set the input frequency of the primary input power

Adjustment Range:

50

50 Hz

60

60 Hz

Default Value: 60



AL 1 1

Alarm 1 Type

Function: Sets the action of the alarm to one of the following choices:

Adjustment Range:

P_H I

P_L o

nonE

Process High: Alarm will activate when the process value equals or exceeds the Alarm 1 setting

Process Low: Alarm will activate when the process value equals or is less than the Alarm 1 setting

No Alarm: Alarm 1 will be activate

Default Value: Process High Alarm



AL 2 2

Alarm 2 Type

Function: Sets the action of the alarm to one of the following choices:

Adjustment Range:

P_H I

P_L o

nonE

Process High: Alarm will activate when the process value equals or exceeds the Alarm 2 setting

Process Low: Alarm will activate when the process value equals or is less than the Alarm 2 setting

No Alarm: Alarm 2 will be activate

Default Value: No Alarm



CONFIGURATION MODE *Continued*

Out 1 u

Output 1 Usage

Function: Determines how the transistor and relay for output 1 will operate

Adjustment Range:

R 1 n d

Alarm 1, Non latching, Direct Action: The output will be On when Alarm 1 is activate, and turn Off once the Alarm 1 condition is no longer present

R 1 n r

Alarm 1, Non latching, Reverse Action: The output will be On when Alarm 1 is inactive, and turn Off when the Alarm 1 condition is present

R 1 L d

Alarm 1, Latching, Direct Action: The output will be On when Alarm 1 is activate, and turn Off only when reset via the front panel

R 1 L r

Alarm 1, Latching, Reverse Action: The output will be On when Alarm 1 is inactive, and turn Off only when reset via the front panel

O 1 2 d

Logical OR of Alarm 1 & 2, Direct Action: The output will be On when a logical OR condition between Alarm 1 and Alarm 2 is present

O 1 2 r

Logical OR of Alarm 1 & 2, Reverse Action: The output will be On when a logical OR condition between Alarm 1 and Alarm 2 is not present

Default Value: Alarm 1, Non latching, Direct Action



Out 2 u

Output 2 Usage

Function: Determines how the transistor and relay for output 2 will operate

Adjustment Range:

R 2 _ d

Alarm 2, Direct Action: The output will be On when Alarm 2 is activate, and turn Off once the Alarm 2 condition is no longer present

R 2 _ r

Alarm 2, Reverse Action: The output will be On when Alarm 2 is inactive, and turn Off when the Alarm 2 condition is present

O 1 2 d

Logical OR of Alarm 1 & 2, Direct Action: The output will be On when a logical OR condition between Alarm 1 and Alarm 2 is present

O 1 2 r

Logical OR of Alarm 1 & 2, Reverse Action: The output will be On when a logical OR condition between Alarm 1 and Alarm 2 is not present

Default Value: Alarm 2, Direct Action



CONFIGURATION

CONFIGURATION MODE *Continued*

rt Ent

Retransmission Output

Function: Selects the range of the retransmission output

Adjustment Range:

none

None

0-5v

0-5 Volts DC

0-10v

0-10 Volts DC

0-20A

0-20 mA

4-20A

4-20 mA

Default Value: None



PRG

Optn

Option Selection

Function: Determines the function of the board installed in the option slot

Adjustment Range:

none

No Input

Security

Security: When the digital input is active, the Program and Configuration Modes cannot be accessed

TARE

Tare: When the digital input is activated the currently measured value is zeroed out and will remain as a constant offset

Comm

Communication: The slot will be used for RS-485 communication

Default Value: None

tot t

Totalizer Scale Factor

Function: Sets the time base used for the totalization calculation. This value should be set the same as the time base used for the engineering units which appear on the display. Ex: If the display is calibrated to display GPM, set the Totalizer scale factor to minutes

Adjustment Range:

Sec

Seconds

min

Minutes

hr

Hours

Default Value: Seconds

SPECIFICATIONS

Process Input

Range: To 50 mA, ± 10 Volts DC, ± 100 mV
 Accuracy: $\pm 0.01\%$ of span
 Sample Rate: 100 ms
 Resolution: 14 bits
 Sensor Break: Detected within 2 seconds

Control Inputs

Type: Sourcing, Edge Sensitive
 Logic: Low ≤ 2.0 VDC, High ≥ 3.0
 Impedance: 4.7 K Ω to +Voltage - Sourcing
 Response Time: 25 ms
 Function: Programmable

Outputs

Solid State: NPN open collector, 30 VDC max, 100 mA max.
 Relay: SPDT, 5A resistive @ 110VAC
 Latency: 75 μ seconds, plus 8 ms for relay pull-in

Linear Outputs

Ranges: 0-20mA, 4-20mA, 0-10V, 2-10V, 0-5V, 1-5V
 Accuracy: $\pm 0.25\%$ (mA at 250 Ω , V at 2k Ω);
 degrades linearly to $\pm 0.5\%$
 Resolution: 8 bits in 250ms (10 bits in 1s typ.)
 Update: Approximately 4/s
 Load Impedence: mA Ranges: 500 Ω max.; V Ranges: 500 Ω min.

Approvals

General: CE
 EMC Susceptibility: Complies with EN50082-1: 1992,
 EN50082-1, 1995
 EMC Emissions: Complies with EN50081-1: 1992,
 EN50081-2: 1994
 Safety: Complies with EN61010-1: 1993

Communication

Type: Serial asynchronous, UART to UART
 Data Format: Open ASCII: One start bit, even parity seven data
 bits, one stop bit
 Physical Layer: RS-485
 Maximum Zones: 99
 Baud Rate: Selectable from 9600, 4800, 2400, or 1200

Electrical

Supply Voltage: 90-264 VAC, 50/60 Hz, or 20-50 VAC/VDC
 Power Consumption: 4 Watts
 Access. Power Supply: 24 VDC @ 30 mA

Display

Type: Red/Green, 7 segment LED, 5 digits primary
 display, single digit secondary display
 Height: 0.71" (18mm) primary display,
 0.3" (7mm) secondary display
 Annunciators: Output 1 & 2 status

Physical

Dimensions: 48mm x 96mm, 110mm deep
 Mounting: Panel mount (mounting bracket supplied),
 45mm x 92mm cutout
 Terminals: Screw type - combination head
 Front Panel Rating: NEMA 4X/IEC IP65
 Case Material: GE Lexan 940
 Weight: 0.56 lbs.

Environmental

Operating Temp.: 0° to 55° Celsius, 32° to 131° Fahrenheit
 Storage Temp.: -20° to 80° Celsius, -4° to 176° Fahrenheit
 Relative Humidity: 20% to 95% non-condensing

ORDERING INFORMATION

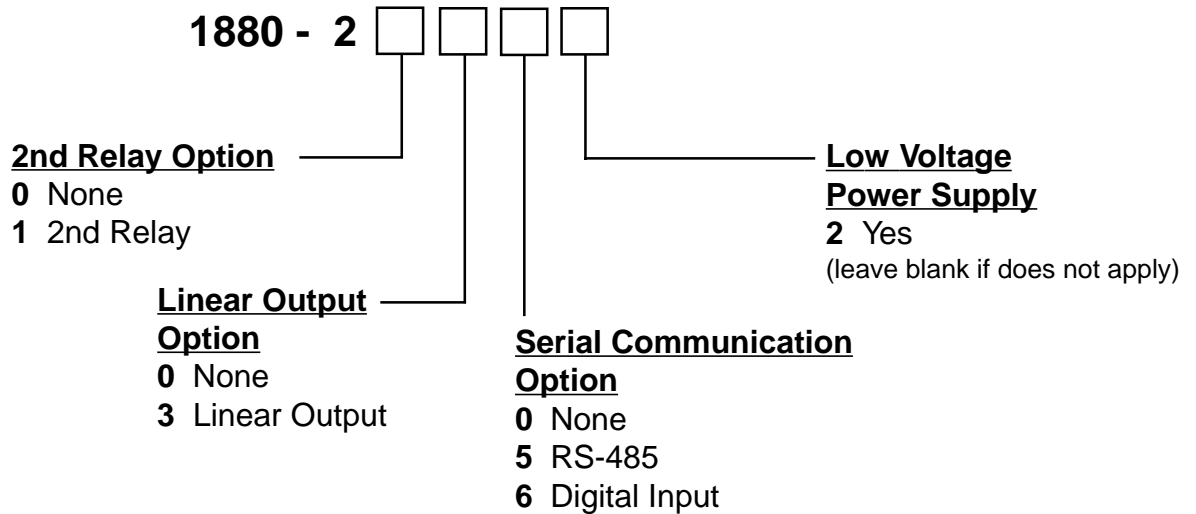

WARRANTY

Standard products manufactured by the Company are warranted to be free from defects in workmanship and material for a period of one year from the date of shipment, and products which are defective in workmanship or material will be repaired or replaced, at the option of the Company, at no charge to the Buyer. Final determination as to whether a product is actually defective rests with the Company. The obligation of the Company hereunder shall be limited solely to repair and replacement of products that fall within the foregoing limitations, and shall be conditioned upon receipt by the Company of written notice of any alleged defects or deficiency promptly after discovery within the warranty period, and in the case of components or units purchased by the Company, the obligation of the Company shall not exceed the settlement that the Company is able to obtain from the supplier thereof. No products shall be returned to the Company without its prior consent. Products which the Company consents to have returned shall be shipped

F.O.B. the Company's factory. The Company cannot assume responsibility or accept invoices for unauthorized repairs to its components, even though defective. The life of the products of the Company depends, to a large extent, upon the type of usage thereof, and THE COMPANY MAKES NO WARRANTY AS TO FITNESS OF ITS PRODUCTS FOR SPECIFIC APPLICATIONS BY THE BUYER NOR AS TO PERIOD OF SERVICE UNLESS THE COMPANY SPECIFICALLY AGREES OTHERWISE IN WRITING AFTER THE PROPOSED USAGE HAS BEEN MADE KNOWN TO IT.

THE FOREGOING WARRANTY IS EXCLUSIVE AND IN LIEU OF ALL OTHER WARRANTIES EXPRESSED OR IMPLIED, INCLUDING, BUT NOT LIMITED TO ANY WARRANTY OF MERCHANTABILITY OR OF FITNESS FOR A PARTICULAR PURPOSE.